

THIRD & BROADWAY PROMENADE



CONTENT

INTERIOR

- STACKING DIAGRAM
- METRICS
- FLOOR LAYOUTS
- INDUSTRIAL MINIMALISM
 - LOOK & FEEL
 - PLANNING
 - RENDERINGS
 - ELEVATIONS
- URBAN CHIC
 - LOOK & FEEL
 - PLANNING
 - RENDERINGS
 - ELEVATIONS
- SUMMARY
- DOOR SCHEDULE

ARCHITECTURAL



RENDERINGS | 3RD ST & N BROADWAY



RENDERINGS | 3RD ST & N SYCAMORE STREET



RENDERINGS | 3RD ST & N SYCAMORE STREET



RENDERINGS | 3RD ST



RENDERINGS | 3RD ST & N SYCAMORE STREET



INTERIOR



UNIT MIX | STACKING DIAGRAM

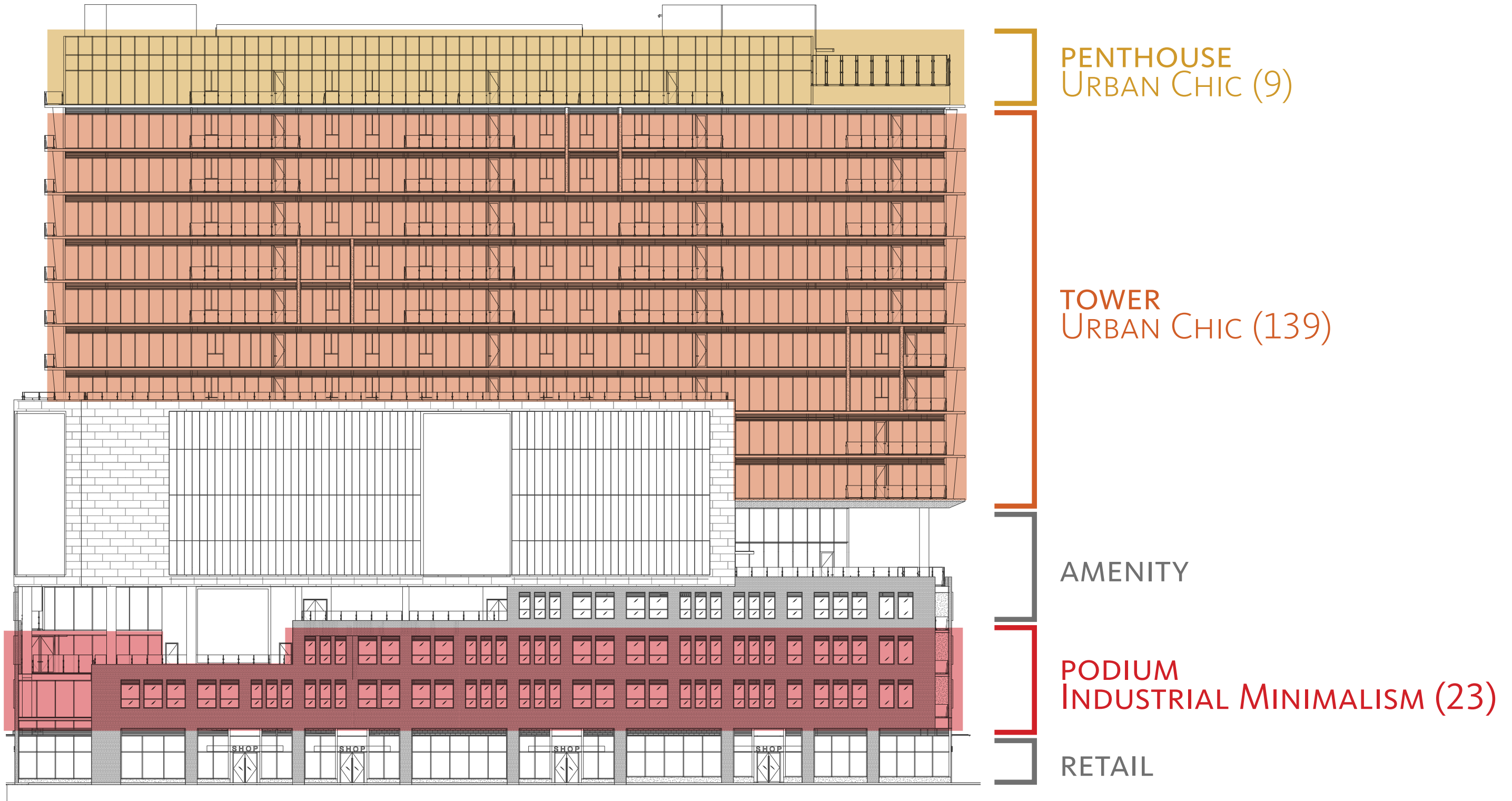

UNIT MIX | METRICS

RESIDENTIAL UNIT SUMMARY - OPTION 3				
	STUDIO	1 BED	2 BED	TOTAL
L1	-	-	-	-
L2	10	1	1	12
L3	11	-	-	11
L4	-	-	-	0
L5	-	-	-	0
L6	-	-	-	0
L7	2	-	1	3
L8	2	-	1	3
L9	10	7	2	19
L10	10	7	2	19
L11	10	7	2	19
L12	10	7	2	19
L13	10	7	2	19
L14	10	7	2	19
L15	10	7	2	19
L16	-	1	8	9
TOTAL	95	51	25	171

	Type	Quantity	SF
2BR	1	1	1,750
	2	2	1,310
	3	8	1,337
	4	7	1,274
	5	7	1,407
Total		25	
1BR	1	1	1,009
	2	7	1,007
	3	43	1,058
Total		51	
Studio	1A	7	650
	1B	2	596
	2A	2	730
	2B	2	711
	2C	2	699
	2D	4	725
	3A	2	870
	4A	1	912
	4B	1	828
	3B	2	847
	5	63	589
6	7	601	
Total		95	
Grand Total		171	146,809

FLOOR PLAN | LEVEL 02

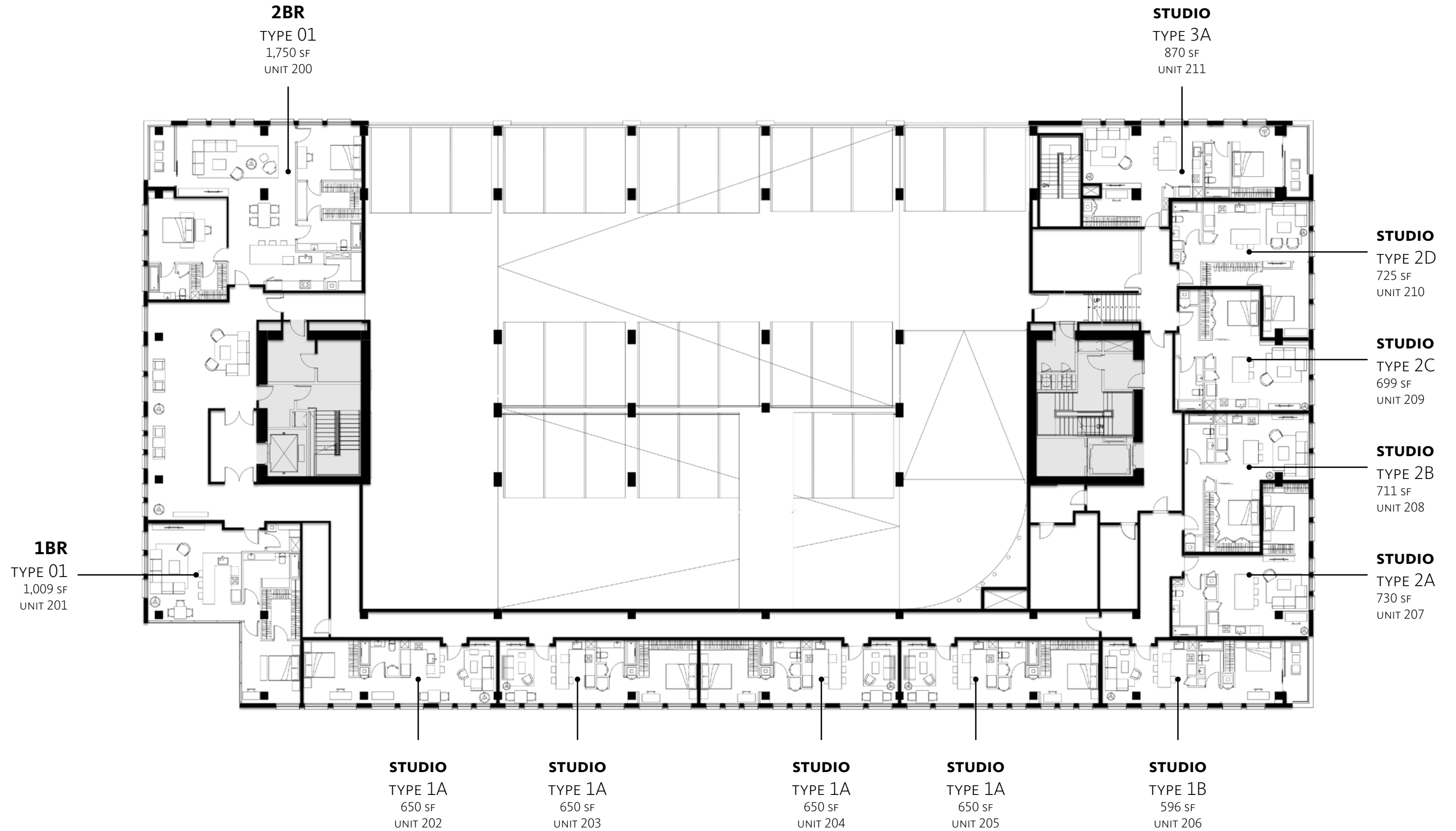

FLOOR PLAN | LEVEL 03

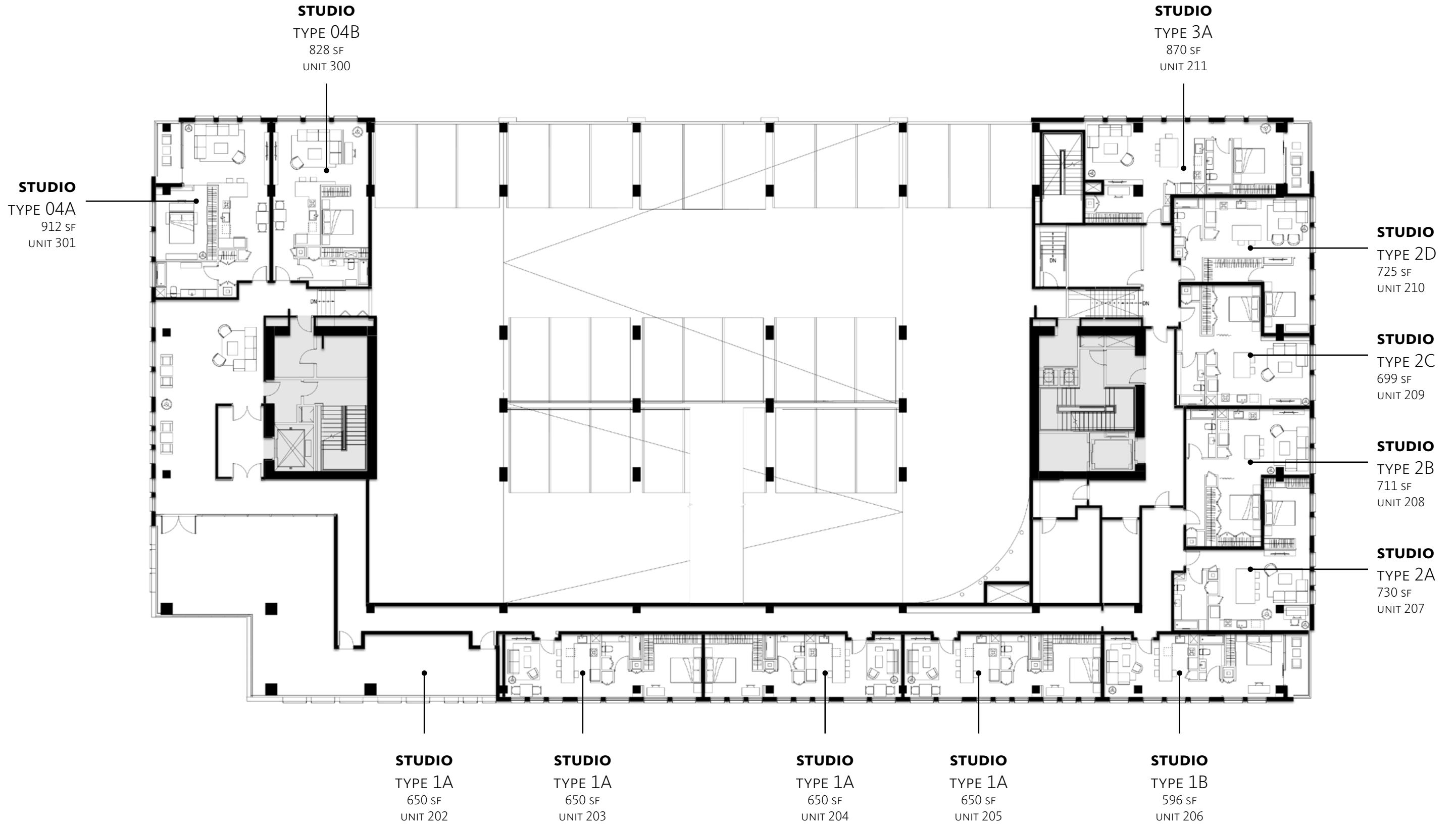

FLOOR PLAN | LEVEL 08

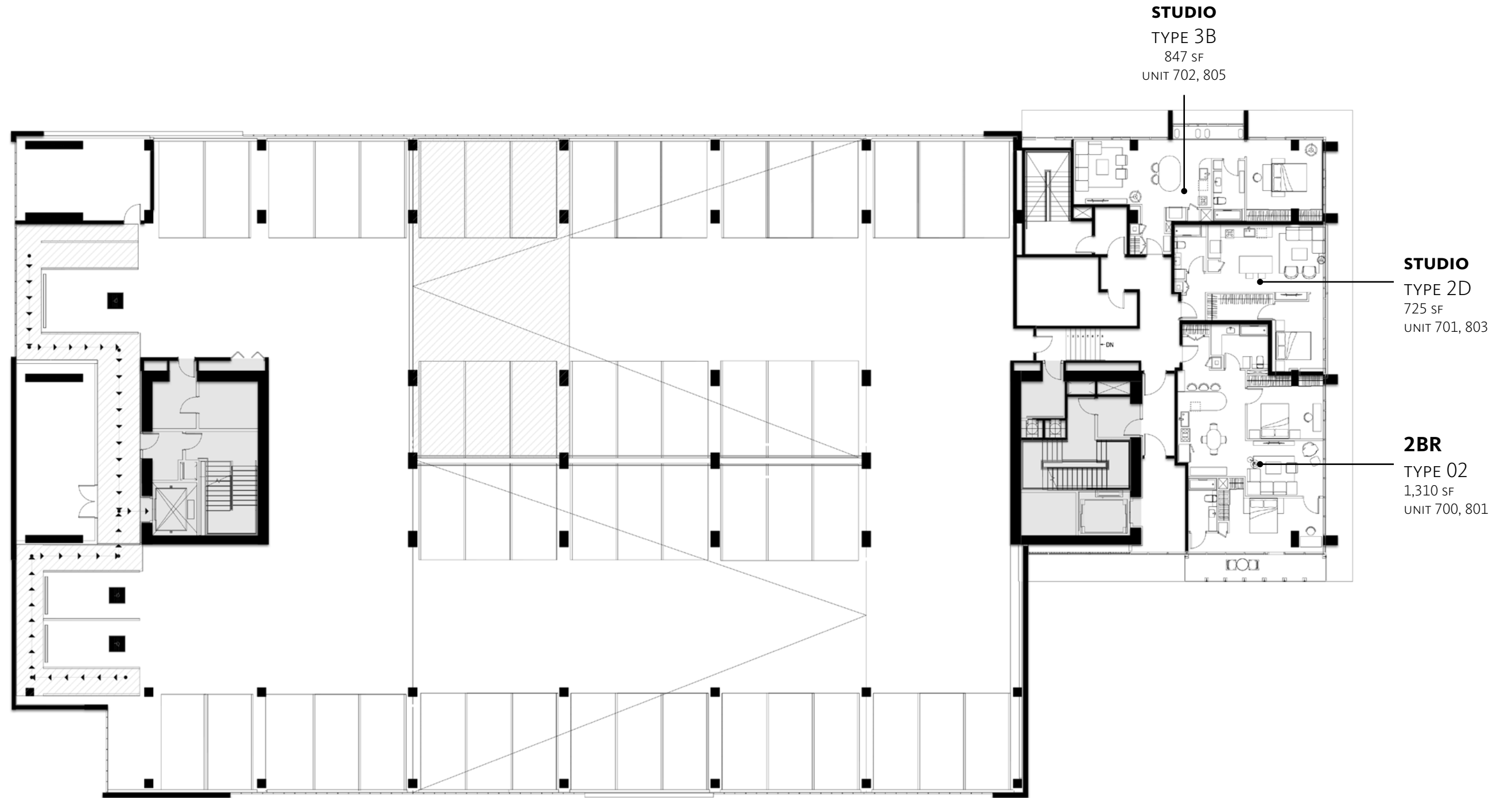

FLOOR PLAN | LEVEL 15



FLOOR PLAN | LEVEL 16



LOOK & FEEL | INDUSTRIAL MINIMALISM



FLOOR PLAN | STUDIO 01A

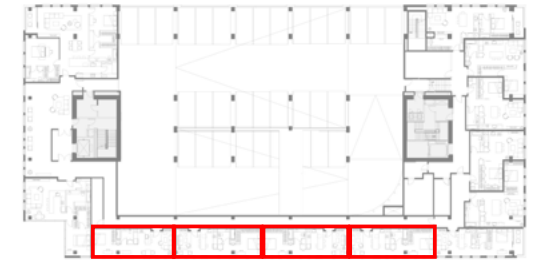

LEVEL 02



650 SQFT

UNIT 202, 203, 204, 205, 303, 304, 305

NUMBER OF UNITS 7

PODIUM LEVEL



FLOOR PLAN | STUDIO 01B

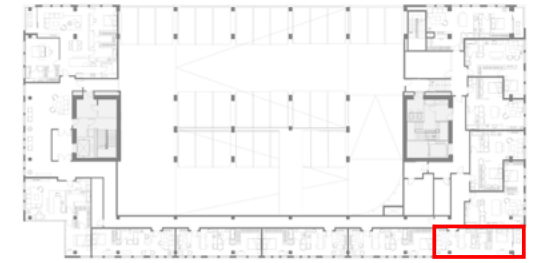

LEVEL 02

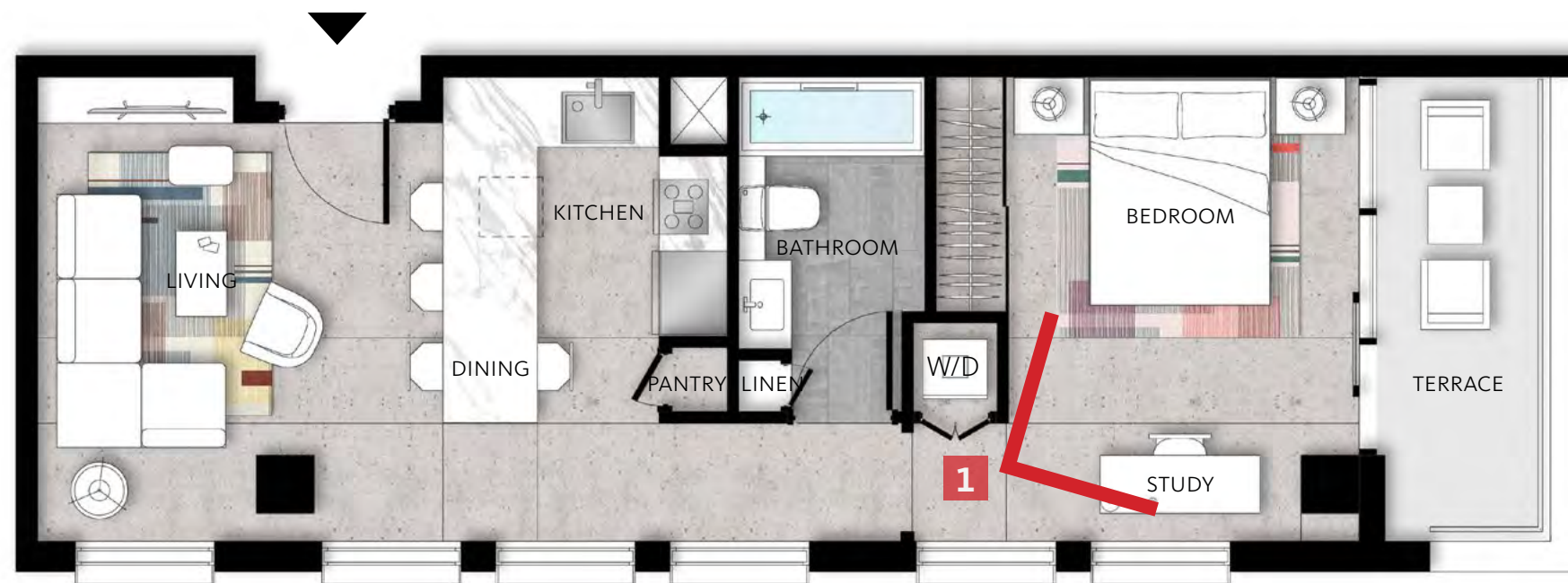

596 SQFT
UNIT 206, 306
NUMBER OF UNITS 2
PODIUM LEVEL

RENDERING | STUDIO 01B



FLOOR PLAN | STUDIO 02A

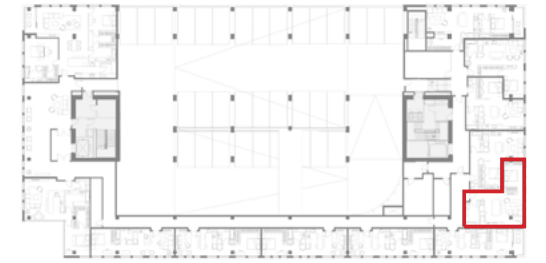

LEVEL 02



730 SQFT
UNIT 207, 307
NUMBER OF UNITS 2
PODIUM LEVEL

ELEVATION | STUDIO 02A

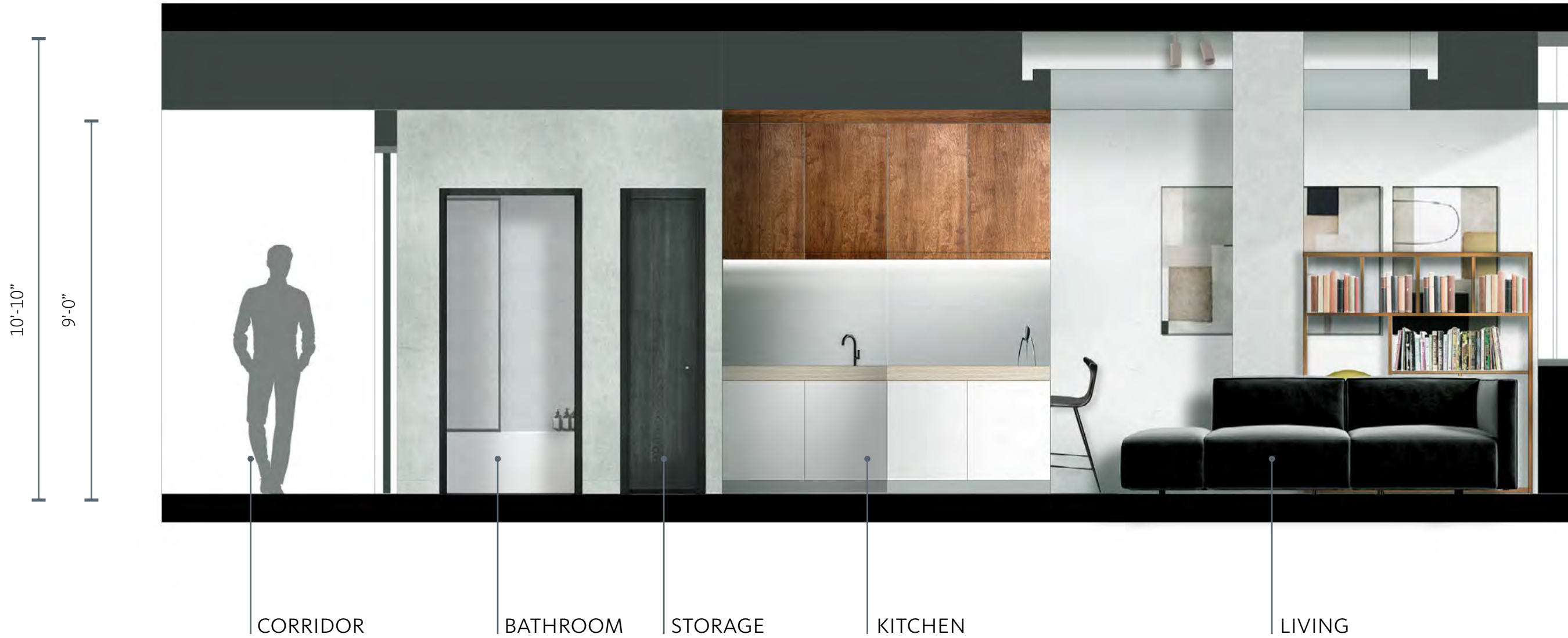

FLOOR PLAN | STUDIO 02B

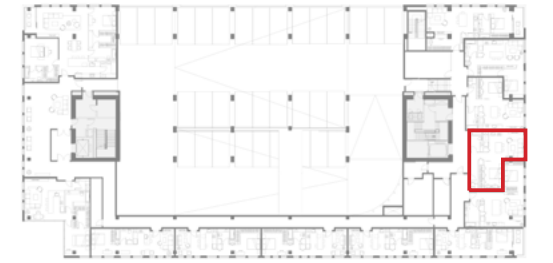

LEVEL 02



711 SQFT
UNIT 208, 308
NUMBER OF UNITS 2
PODIUM LEVEL

FLOOR PLAN | STUDIO 02c

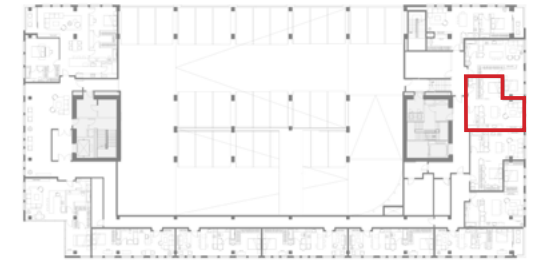

LEVEL 02



699 SQFT
UNIT 209, 309
NUMBER OF UNITS 2
PODIUM LEVEL



FLOOR PLAN | STUDIO 02D

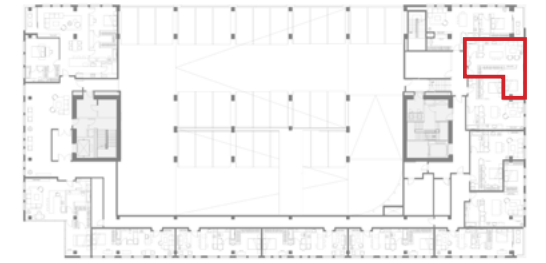

LEVEL 02



725 SQFT

UNIT 210, 310, 701, 803

NUMBER OF UNITS 4

PODIUM LEVEL



FLOOR PLAN | STUDIO 03A

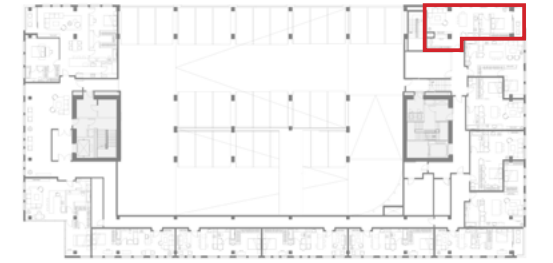

LEVEL 03



870 SQFT
UNIT 211, 311
NUMBER OF UNITS 2
PODIUM LEVEL

RENDERING | STUDIO 03A



FLOOR PLAN | STUDIO 04A

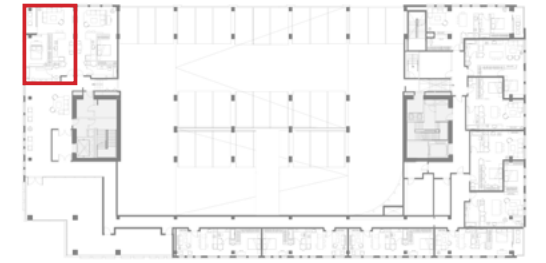

LEVEL 03

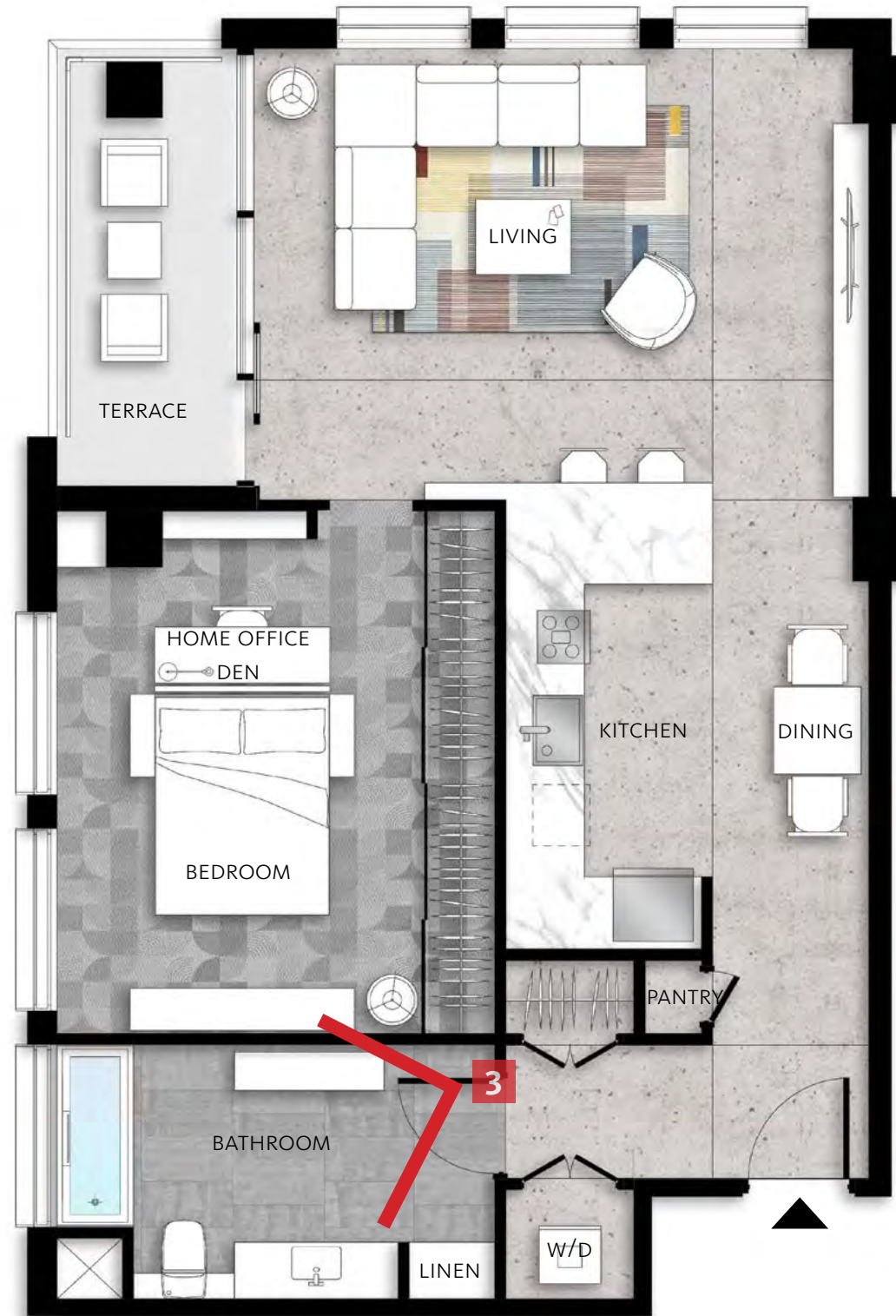

912 SQFT

UNIT 301

NUMBER OF UNITS 1

PODIUM LEVEL





FLOOR PLAN | STUDIO 04B

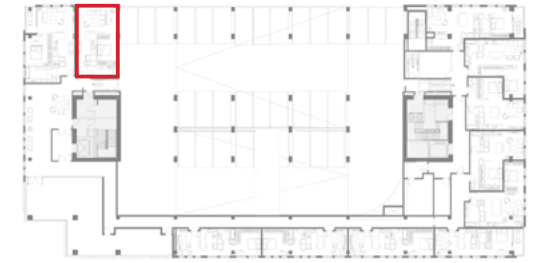

LEVEL 02

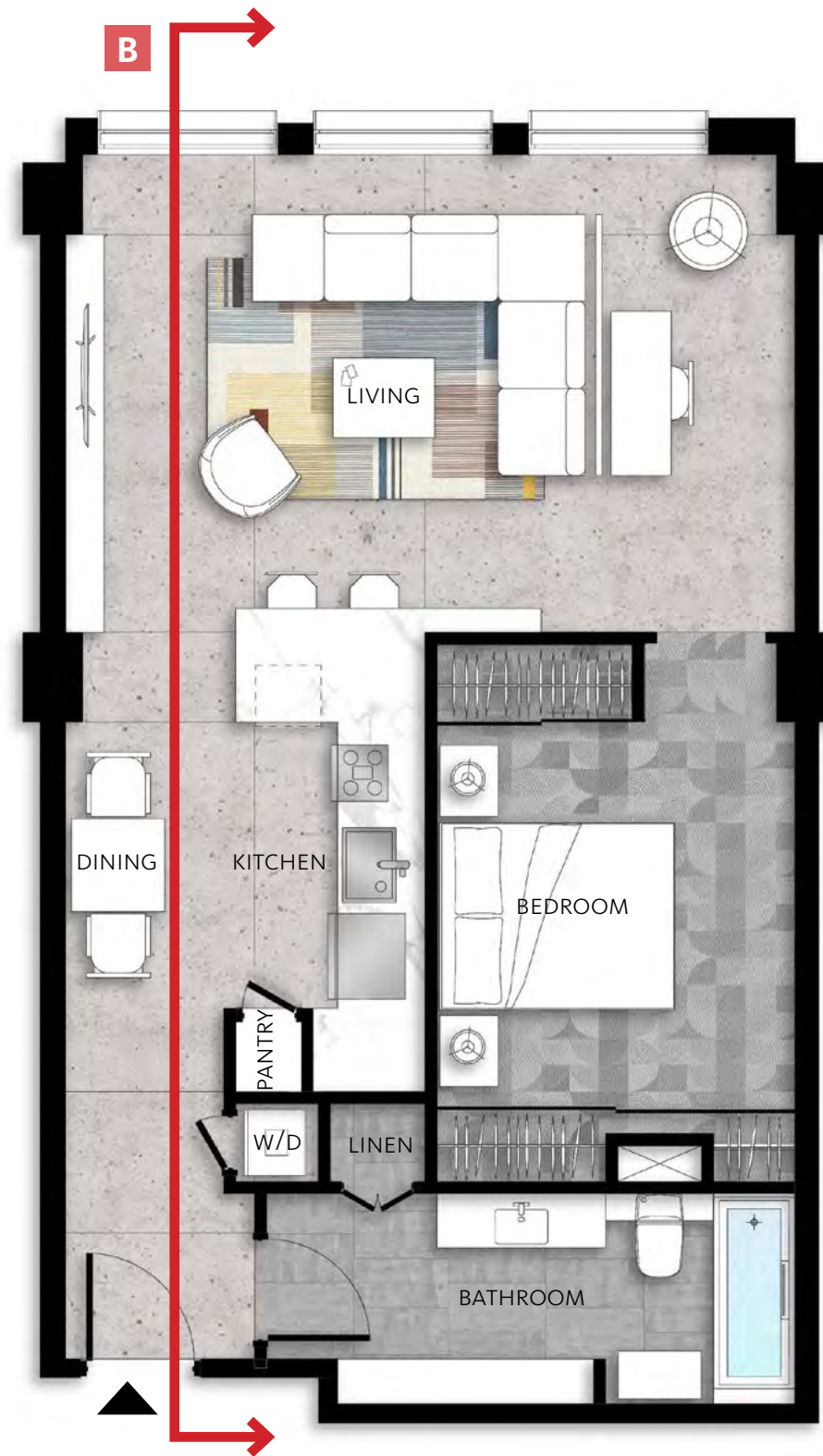

828 SQFT

UNIT 300

NUMBER OF UNITS 1

PODIUM LEVEL



ELEVATION | STUDIO 04B



FLOOR PLAN | ONE-BEDROOM 01

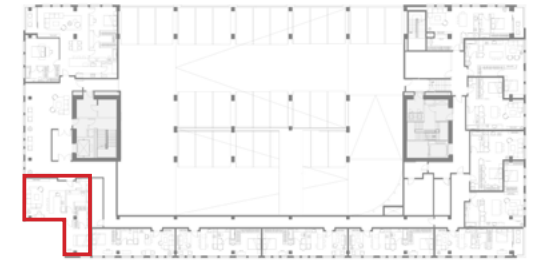

LEVEL 02

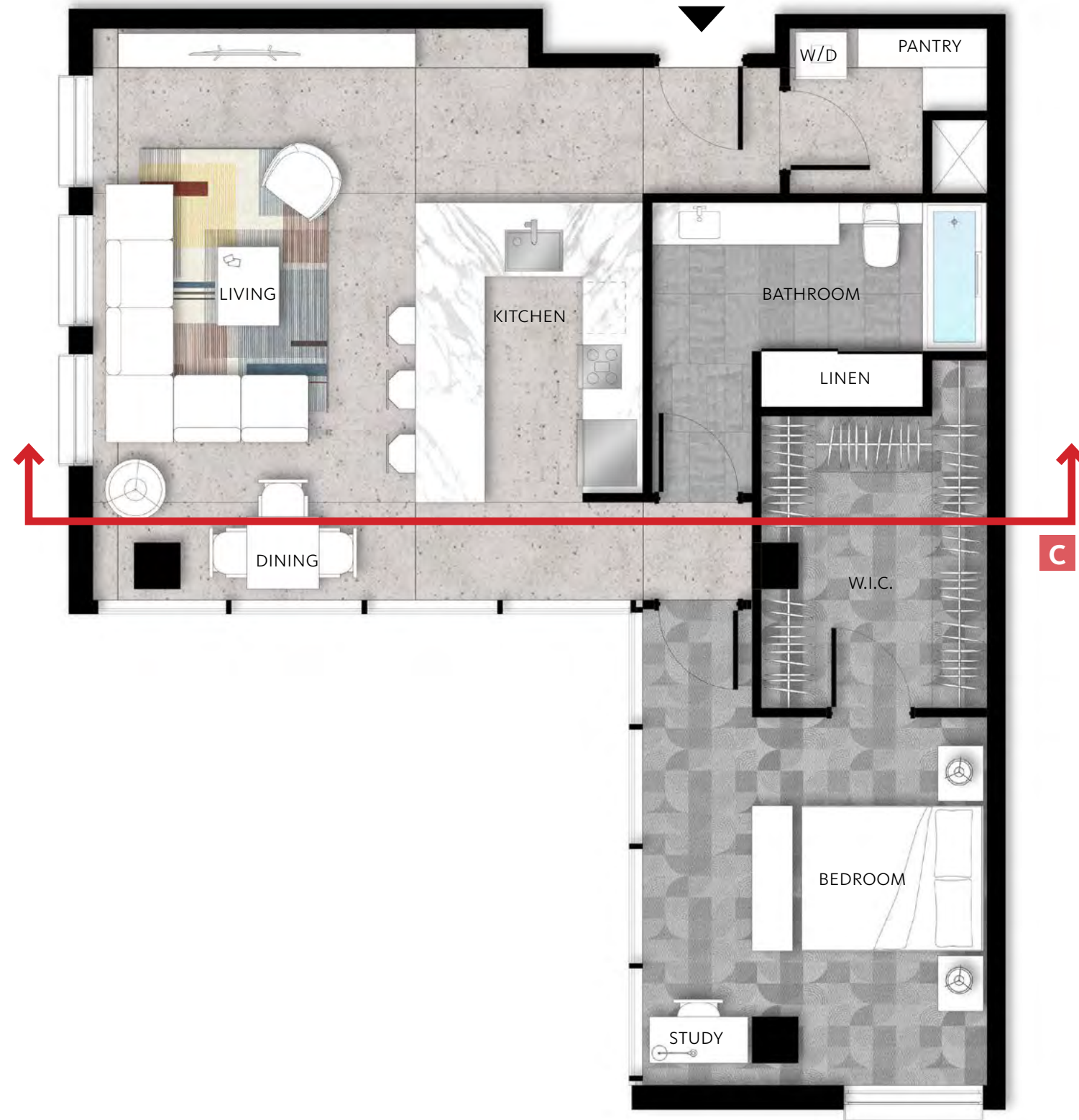

1,009 sqft

UNIT 201

NUMBER OF UNITS 1

PODIUM LEVEL



ELEVATION | ONE-BEDROOM 01

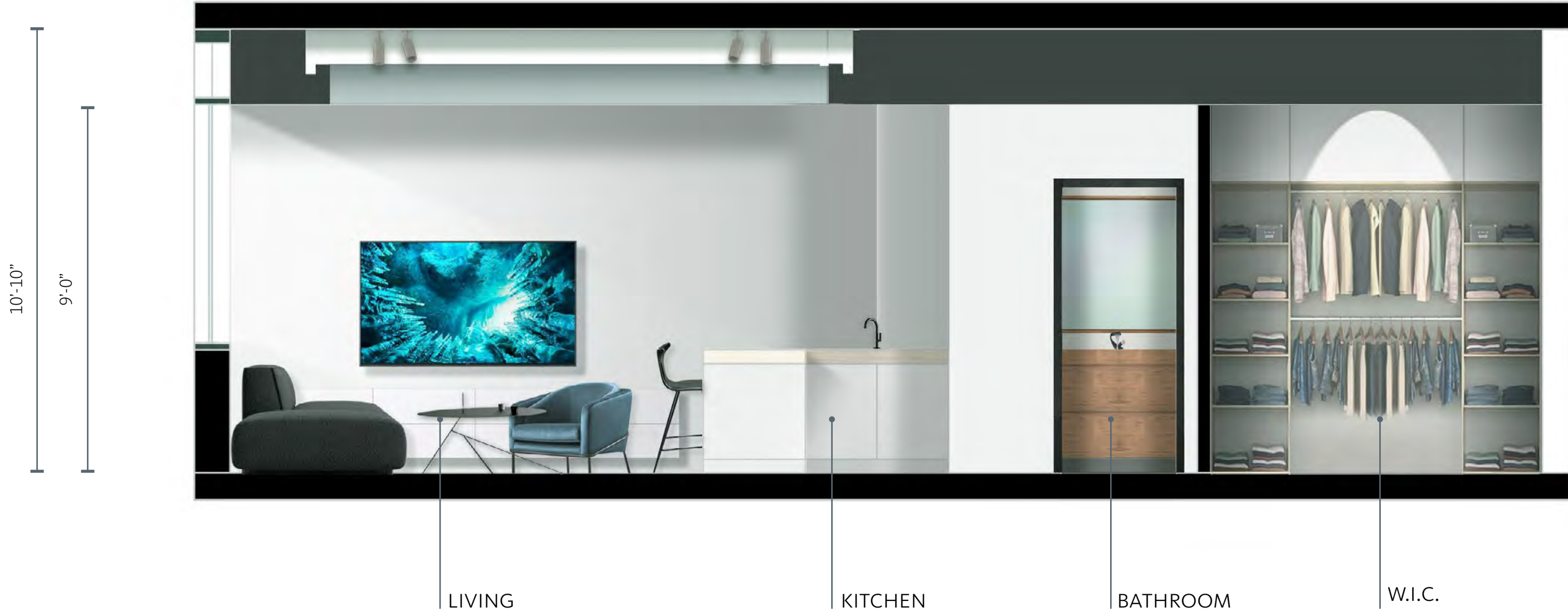
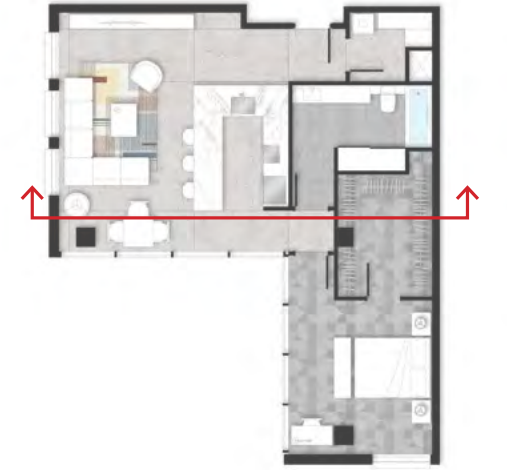

FLOOR PLAN | TWO-BEDROOM 01

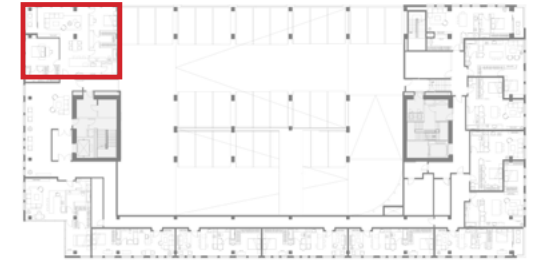

LEVEL 02



1,750 sqft

UNIT 200

NUMBER OF UNITS 1

PODIUM LEVEL



RENDERING | TWO-BEDROOM 01



URBAN CHIC | LOOK & FEEL

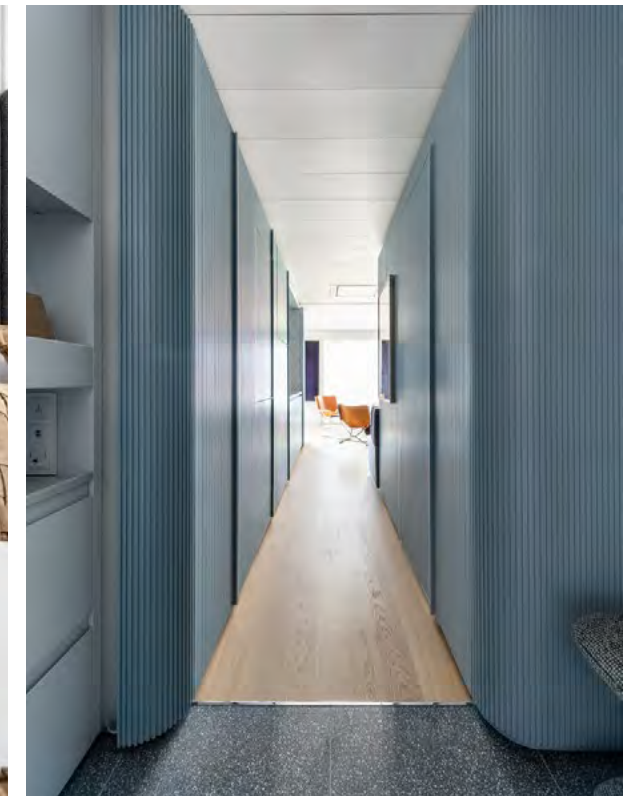

FLOOR PLAN | STUDIO 3B

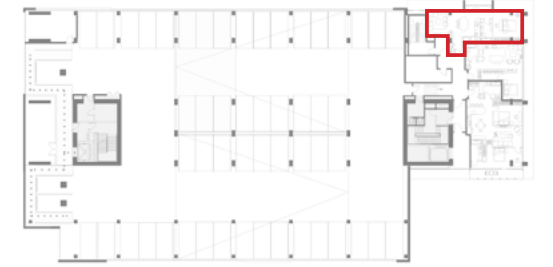

LEVEL 08



847 SQFT
UNIT 702, 805
NUMBER OF UNITS 2
TOWER



RENDERING | STUDIO 3B



FLOOR PLAN | STUDIO 05



LEVEL 15



589 SQFT

UNIT 904~7-1504~7, 910~13-1510~13,
917-1517

NUMBER OF UNITS 63

TOWER



RENDERING | STUDIO 06



FLOOR PLAN | STUDIO 06



LEVEL 15



601 SQFT
UNIT 921-1521
NUMBER OF UNITS 7
TOWER

ELEVATION | STUDIO 06

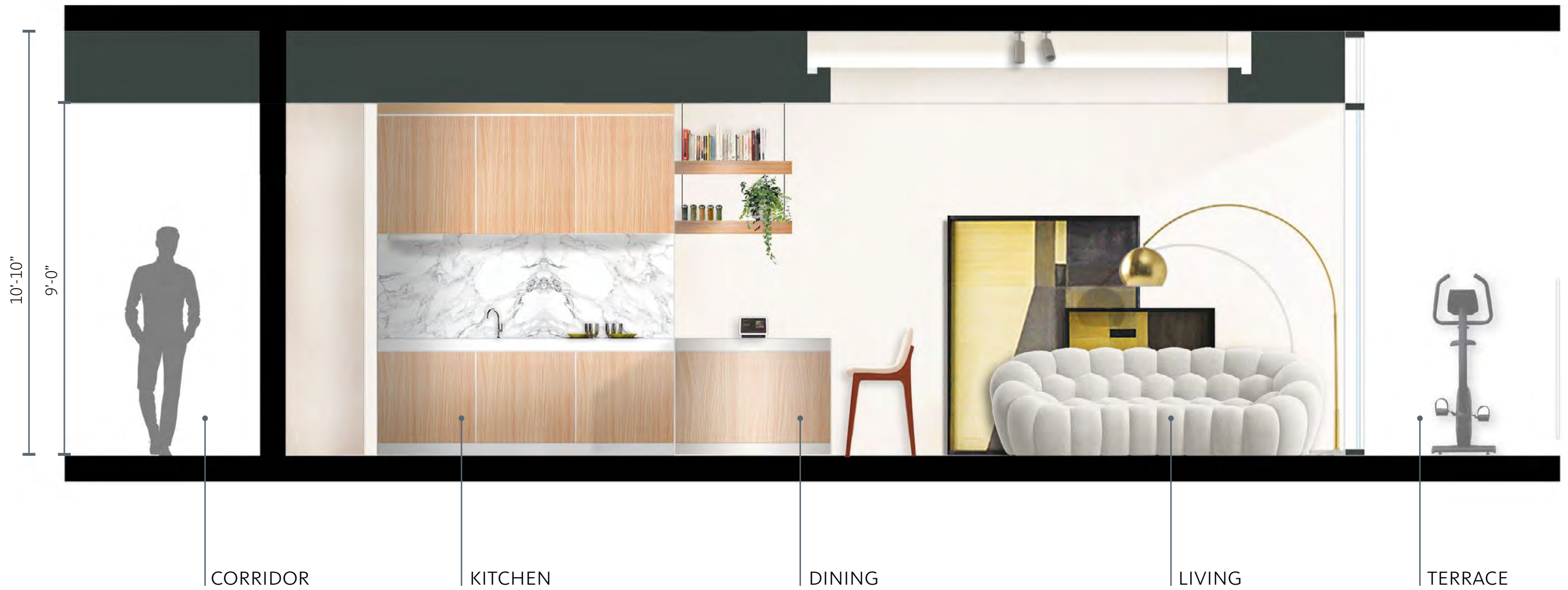

FLOOR PLAN | ONE-BEDROOM 02

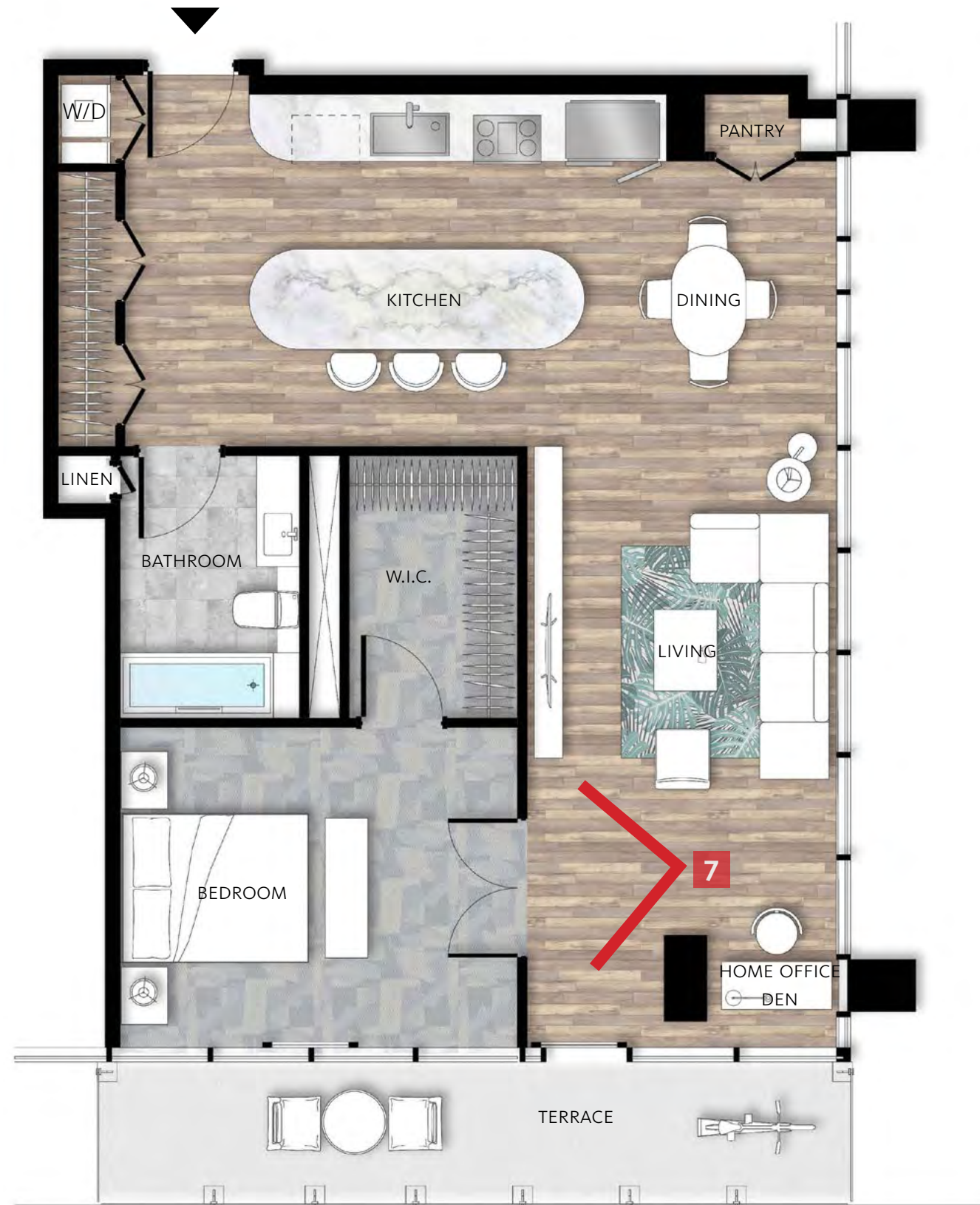

1,007 sqft
UNIT 920-1520
NUMBER OF UNITS 7
TOWER

RENDERING | ONE-BEDROOM 02



FLOOR PLAN | ONE-BEDROOM 03

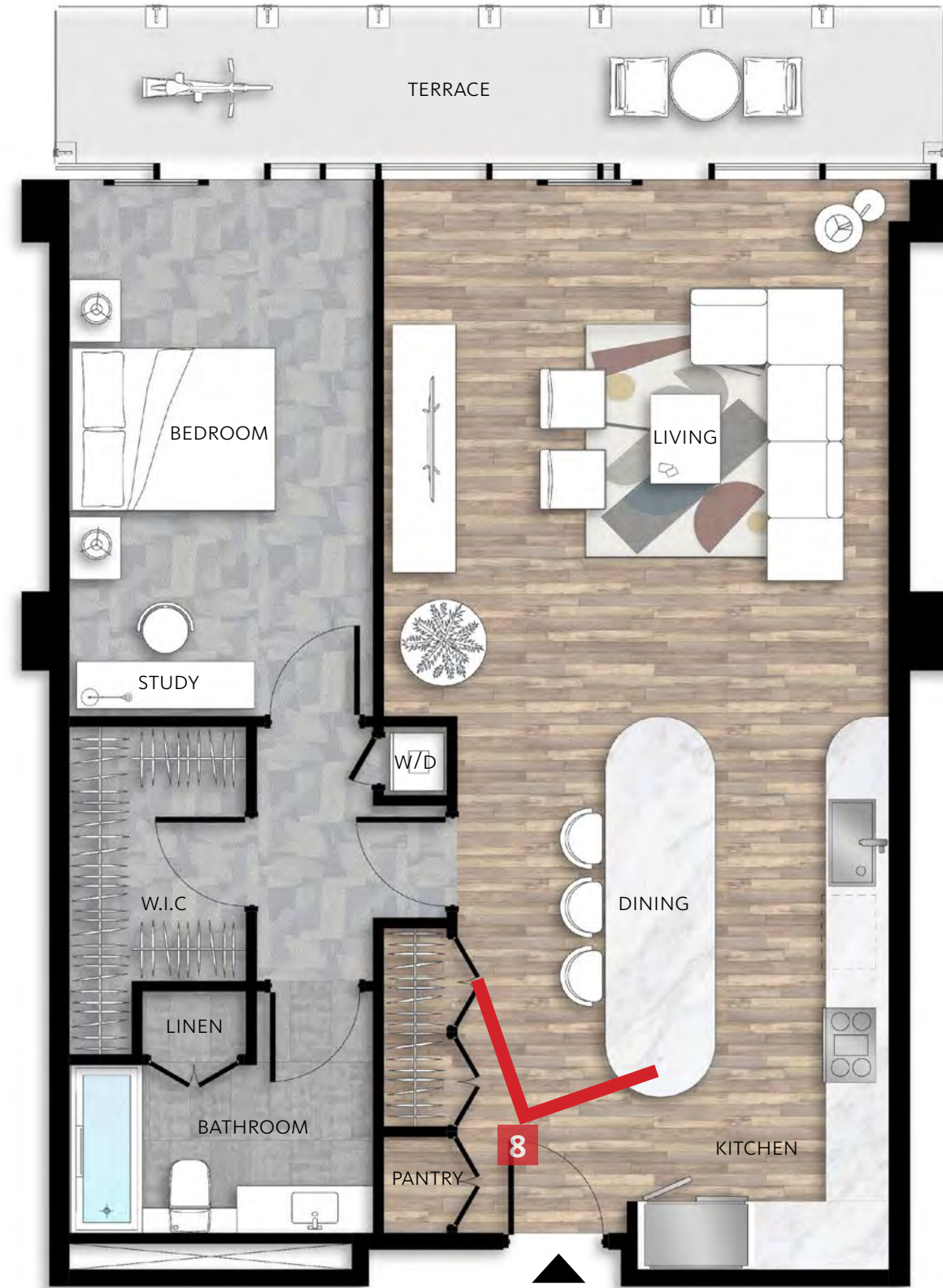

1,058 sqft

UNIT 902~3 -1502~3,
908~9 -1508~9,
914~15 -1514~15, 1608

NUMBER OF UNITS 43
TOWER

RENDERING | ONE-BEDROOM 03



FLOOR PLAN | TWO-BEDROOM 02

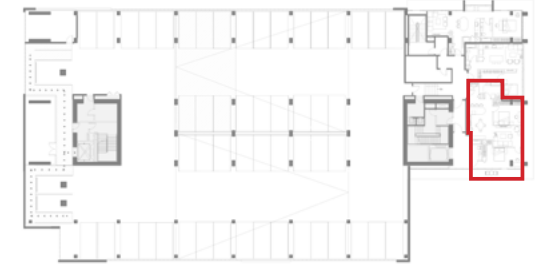

LEVEL 08

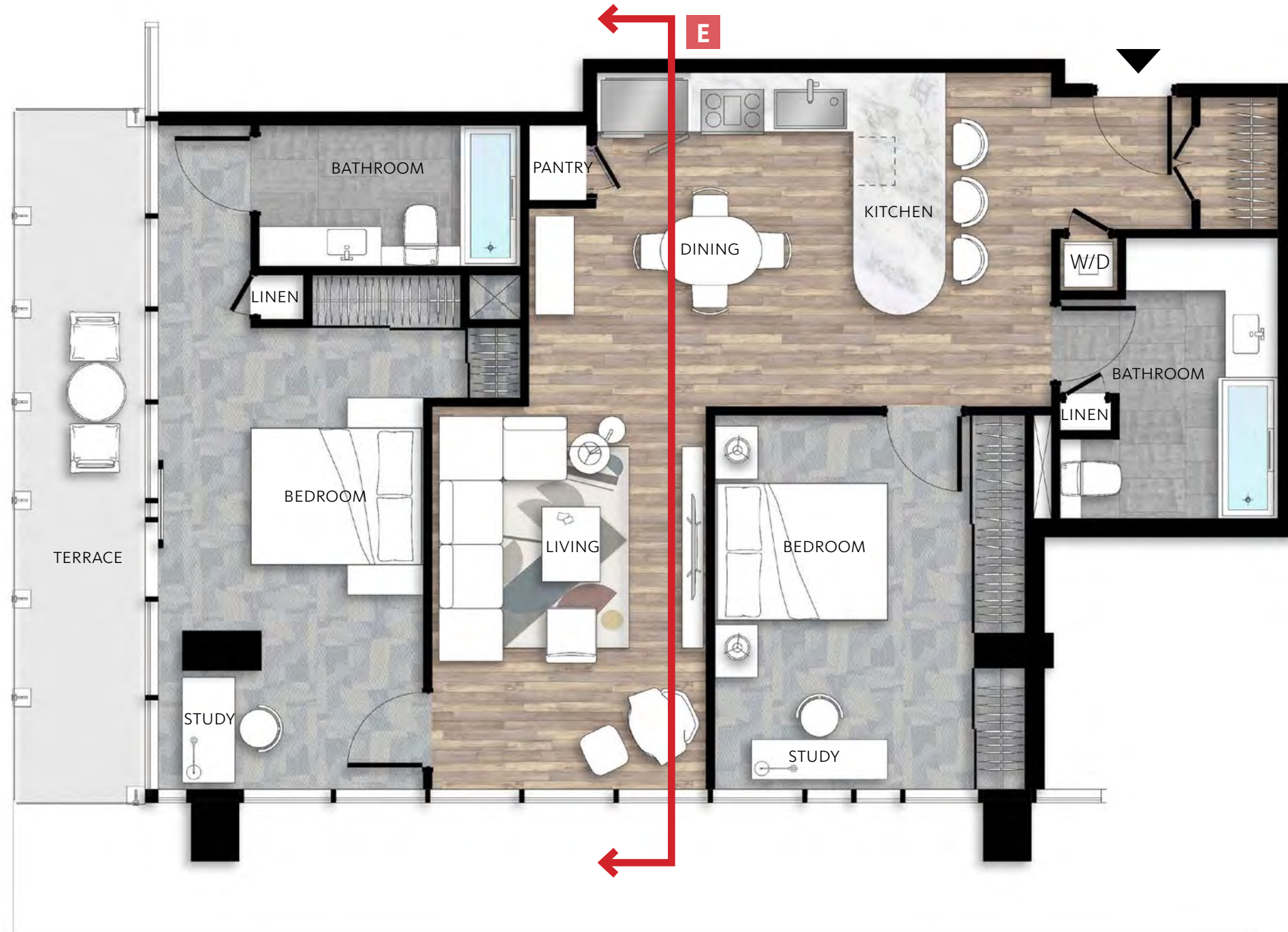

1,310 sqft
UNIT 700, 801
NUMBER OF UNITS 2
TOWER



ELEVATION | TWO-BEDROOM 02

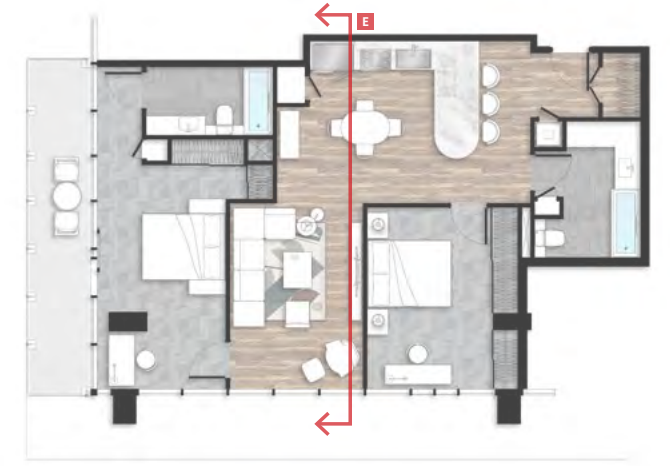

10'-10"
9'-0"

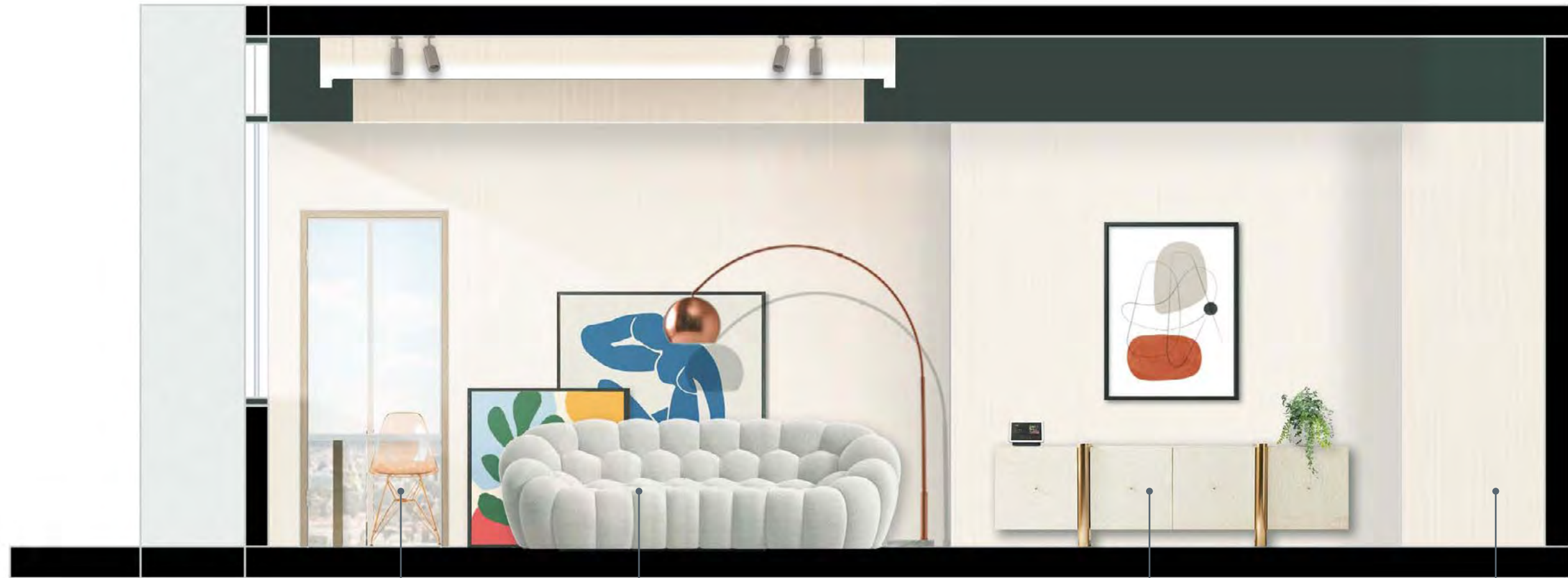

STUDY

LIVING

DINING

KITCHEN

FLOOR PLAN | TWO-BEDROOM 03



LEVEL 16

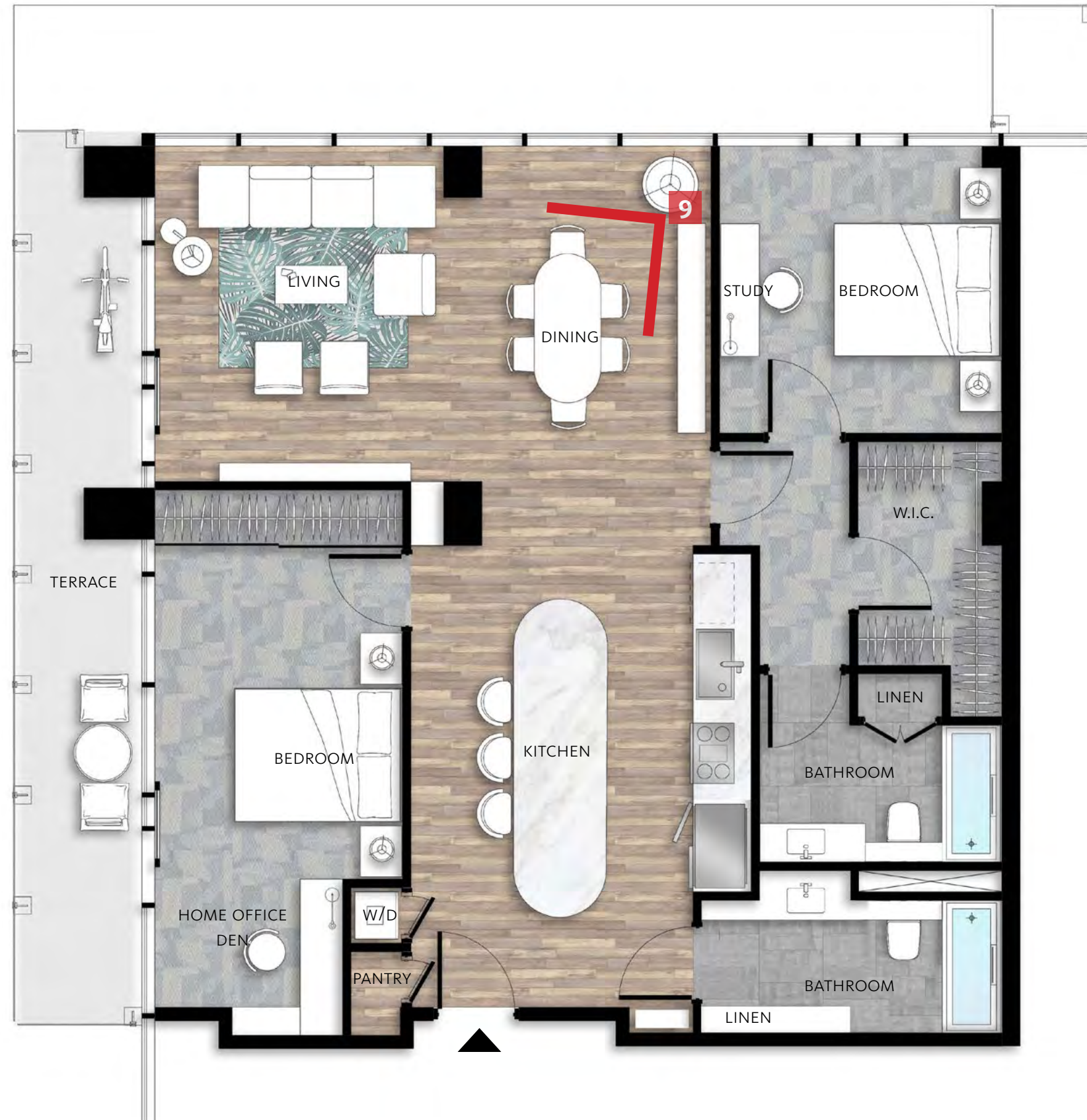

1,337 sqft

UNIT 901-1501,
1602, 1603,
1608, 1609

NUMBER OF UNITS 8
TOWER



RENDERING | TWO-BEDROOM 03



FLOOR PLAN | TWO-BEDROOM 04



LEVEL 15



1,274 sqft
UNIT 919-1519
NUMBER OF UNITS 7
TOWER



ELEVATION | TWO-BEDROOM 04

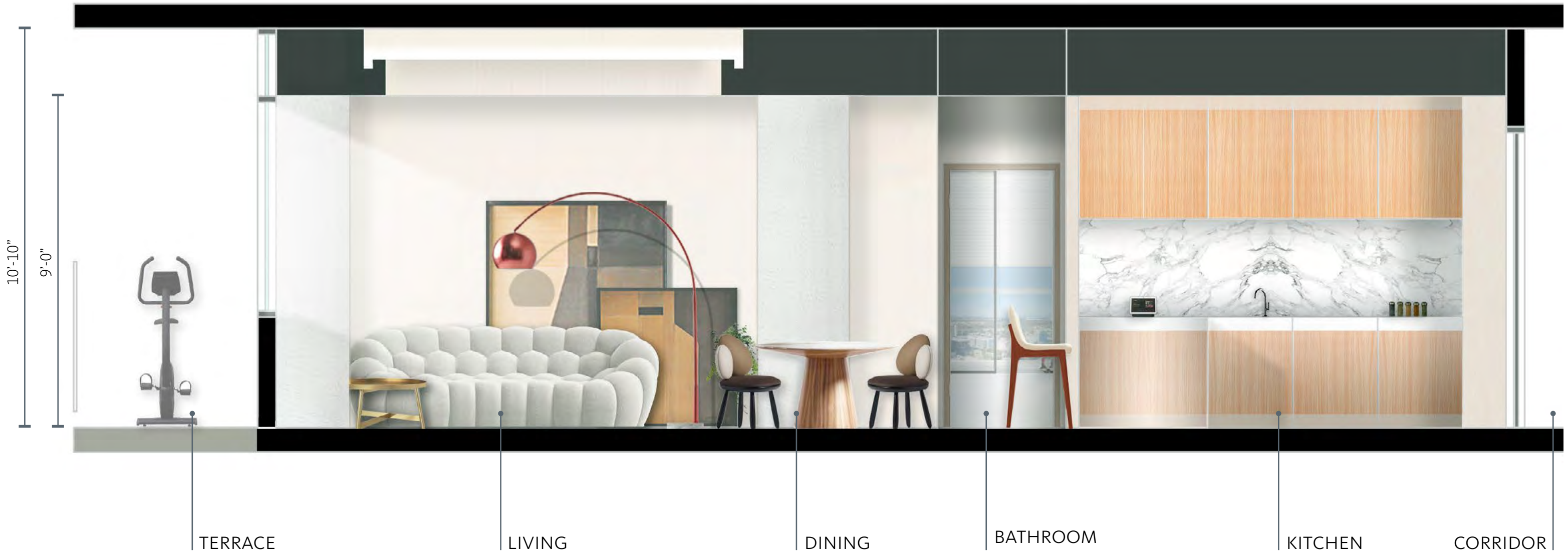
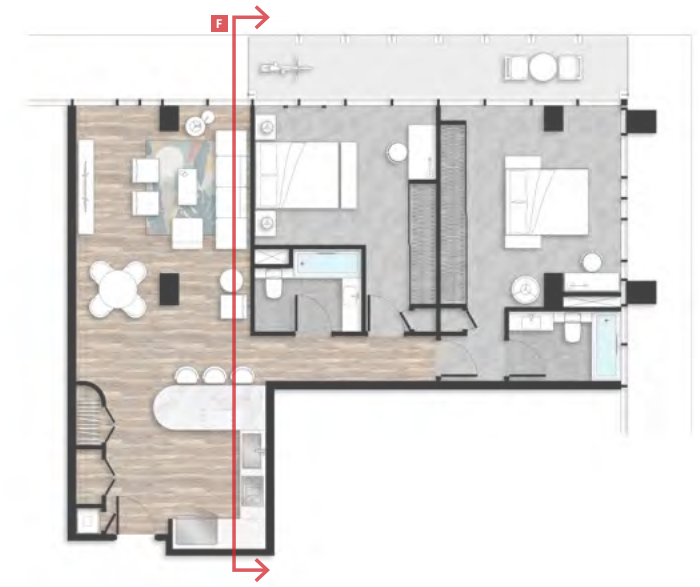

FLOOR PLAN | TWO-BEDROOM 5



LEVEL 16

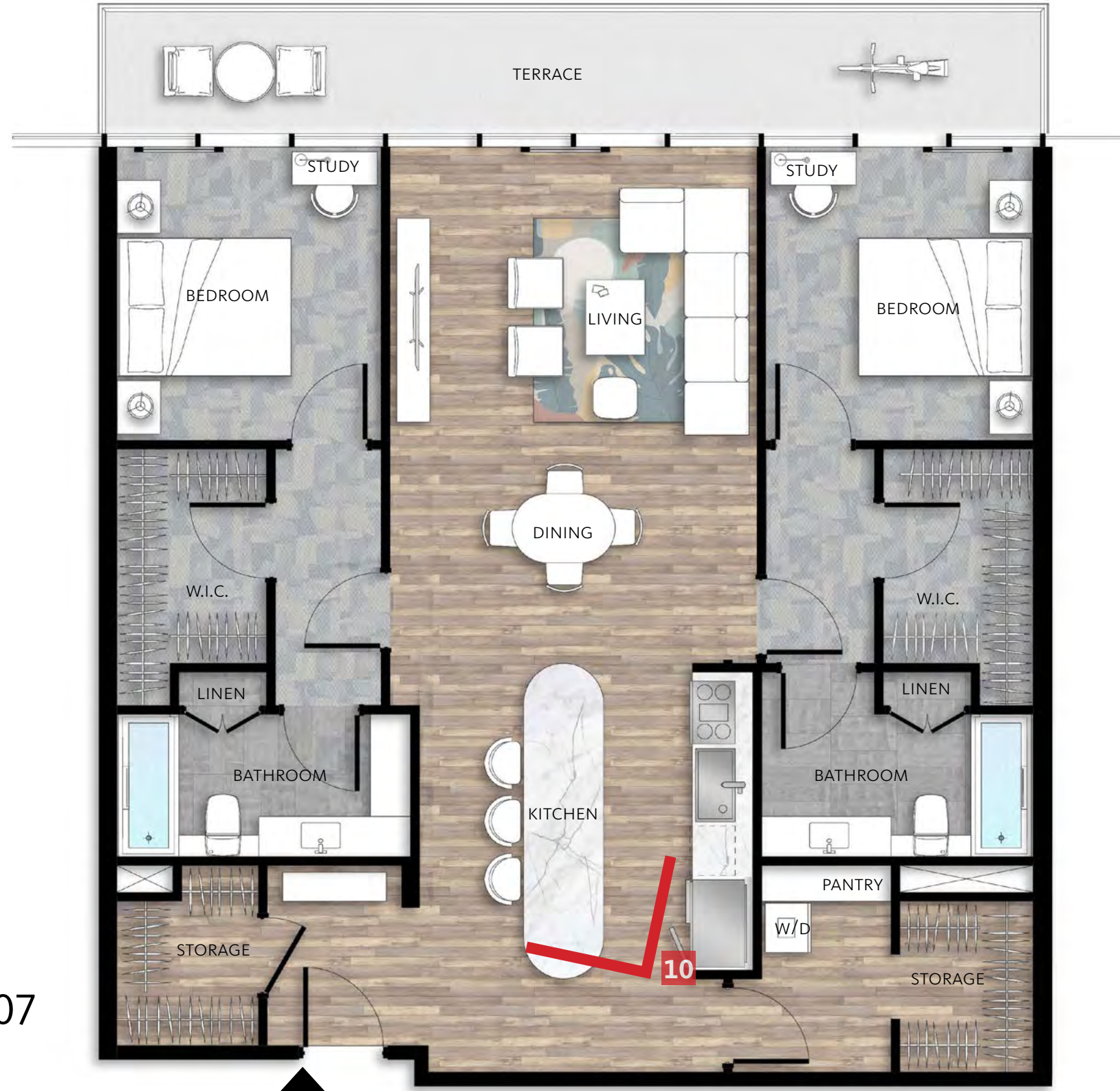

1,407 sqft

UNIT 1604, 1605, 1606, 1607

NUMBER OF UNITS 7

PENTHOUSE



RENDERING | TWO-BEDROOM 05



INDUSTRIAL MINIMALISM | SUMMARY



URBAN CHIC | SUMMARY

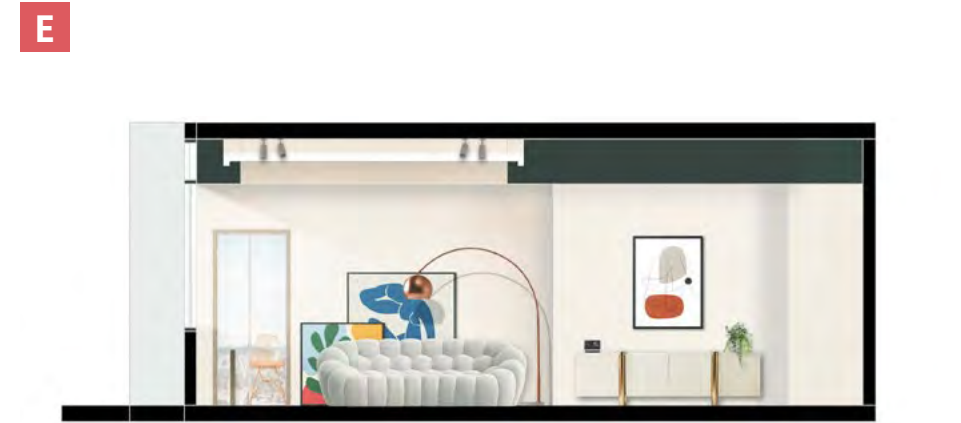

DOOR SCHEDULE | SUMMARY

TYPE	PANEL	PANEL	DOOR	DOOR	PANEL	DOOR PANEL		DOOR FRAME	
	DIMENSIONS	DIMENSIONS	DIMENSIONS	DIMENSIONS	DIMENSIONS				
	WIDTH	HEIGHT	WIDTH	HEIGHT	THICK	MATERIAL	FINISH	MATERIAL	FINISH
A 1.1	3' - 4"	9' - 0"	3' - 0"	8' - 0"	0' - 1 5/8"	WD	DARK	WD	DARK
A 1.2	3' - 4"	8' - 2"	3' - 0"	8' - 0"	0' - 1 5/8"	WD	LIGHT	WD	LIGHT
A 2.1	3' - 2"	7' - 2"	2' - 10"	7' - 0"	0' - 1 3/4"	WD	DARK	WD	DARK
A 2.2	3' - 2"	7' - 2"	2' - 10"	7' - 0"	0' - 1 3/4"	WD	LIGHT	WD	LIGHT
A 3.1	3' - 2"	7' - 2"	1' - 5"	7' - 0"	0' - 1 3/4"	WD	DARK	WD	DARK
A 3.2	3' - 2"	7' - 2"	1' - 5"	7' - 0"	0' - 1 3/4"	WD	LIGHT	WD	LIGHT
A 4.1	2' - 4"	7' - 2"	1' - 0"	7' - 0"	0' - 1 3/4"	WD	DARK	WD	DARK
A 4.2	2' - 4"	7' - 2"	1' - 0"	7' - 0"	0' - 1 3/4"	WD	LIGHT	WD	LIGHT
A 5.1	1' - 10"	7' - 2"	1' - 6"	7' - 0"	0' - 1 3/4"	WD	DARK	WD	DARK
A 5.2	1' - 10"	7' - 2"	1' - 6"	7' - 0"	0' - 1 3/4"	WD	LIGHT	WD	LIGHT
A 6.1	1' - 4"	7' - 2"	1' - 0"	7' - 0"	0' - 1 3/4"	WD	DARK	WD	DARK
A 6.2	1' - 4"	7' - 2"	1' - 0"	7' - 0"	0' - 1 3/4"	WD	LIGHT	WD	LIGHT
A 7.1	see drawings	7' - 0"	2' - 6" min	7' - 0"	0' - 1 3/4"	MT	MIRROR	MT	MIRROR

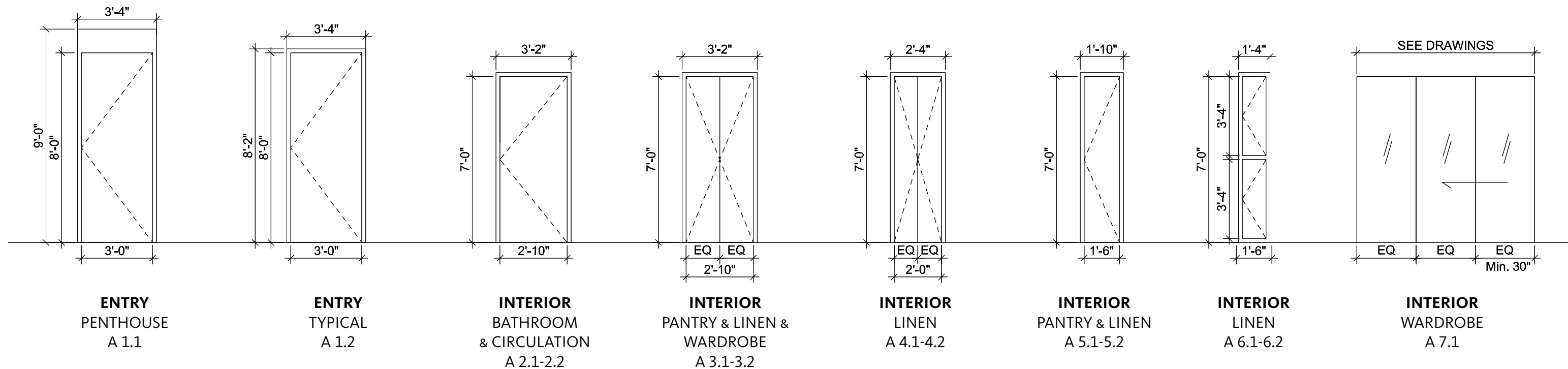

Gensler

30

